

## Introduction

The Switch-Link XP20 is an input module with 8 channels. Potential-free push buttons, switches, sensors and others can be connected to these inputs. The XP20 is similar to the CP20 of the Concept 2000 system, but the difference is that the XP20 uses a bus-connector with 4 poles.

The Switch-Link modules in Concept 2000 XP are required to create modes such as all on, all off, group on/off and so on.

Upon activation of an input, the XP20 sends commands to the local bus. These commands are used by the relay- and/or dimmer-modules to execute the configured actions.

The XP20 cannot be programmed as a real XP-module, but its addressing and programming can be done as with the Concept 2000 system using the Conkey CP79 or the Conbeam XP78 with Contool software.

The inputs of the XP20 module can be changed in order to create special functions such as inverting, AND-functions, short/long and groups on/off. Each data-bus can contain four XP20 modules, which means that there are  $4 \times 8 = 32$  high level functions possible with four XP20 modules. An alternative for the XP20 module is the push button interface XP28, which can be programmed by using the Contool software.

Check the technical description of the XP28.

Note: The XP20 will be changed to an execution on the basis of a XP28, thus also programmable as an XP module.

## Technical specifications

### Low current

Voltage	24VDC
Power consumption	0,5W
8 inputs switched by the minus	
Input current all inputs	0,5 mA
Pulse time short press	between 20-300 msec
Pulse time long press min.	greater than 300 msec

### Mechanical data

Montage Din rail symmetric	Din-rail DIN46277
Dimensions (HxWxD)	85x70x72 mm
Weight	85 g

## Programming special functions by using the Conkey CP79







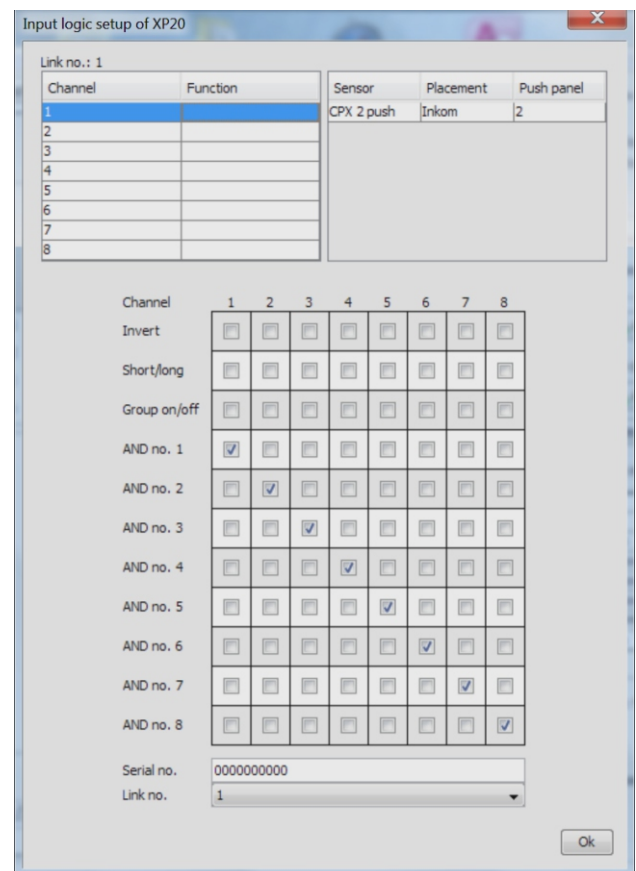



To program special functions with the Conkey CP79, please check the technical sheet of the CP20 ([www.conson.com](http://www.conson.com)).

## Programming special functions by using the software Contool

The special functions are programmable using the input logic setup window of the module, select the tab „Fusebox“ to open it. All the project modules are graphically displayed. Just right-click with the mouse on the chosen XP20 module. The window of the input logic setup will open up. The efficiency of an input channel can be changed by checking the right checkbox.



### The different functions of the XP20 and commands which are sent to the Conbus (Similar for the interfaces XP2506 and XP28)

Input action	Explication	Programmed XP20 functions			Bus-command
		Invert	Grp on/off	Short/long	
	Close contact				START
	Open contact				STOP
	Close contact				STOP
	Open contact				START
	Close contact				Alternating START/STOP
	Open contact				-----
	Short impuls				START
	Long impuls				STOP
	Short impuls				STOP
	Long impuls				START

When closing or opening a contact which is connected to an input of an XP20 a command is sent to the Conbus. No permanent data is transmitted to the bus.

### Explanation and examples of the different functions in relation to the actions applied to the actors.

#### Inverting

When closing the contact on a non-inverted input, the action is immediately executed. For example:

##### Example 1

A magnet contact NC is available in a closet and is connected with input 7 of the XP20. In the window of "input logic setup of the XP20" check the checkbox number 7 on the line „Invert“.

The action of the actor that must turn on and off the light is „auxiliary relay“ (Help function) . When opening the closet, a start-command will be placed on the Conbus and the matching light will turn on. When closing the contact, the stop-command is placed on the Conbus and the light turns off.

##### Example 2

An actor controls the toilet light and the other one controls the ventilation. Whenever the toilet light turns on, it would be great to turn on the ventilation for x-time. The LED-output of the actor (XP24) that controls the light is connected to input 6 of the XP20. Input 6 is inverted. When turning on the toilet light, the LED-output of the actor (XP24) that controls the light is connected with input 6 of the XP20. Input 6 becomes inverted. When turning on the toilet light, the LED-output becomes low of the actor that controls the light. Whenever the toilet light turns off, its LED-output becomes high. This information sends a start-command channel 6 Switch-Link 1 to the bus and the ventilation starts for x-time.

Remark: This way of programming is somehow devious. Using the „Actor programming“ from Contool is much easier and without any feedback cabling.

### Example 3

The wish is to control the blinds up and down with one pushbutton. Install the number of motors on the floor plan and program the relays 1 and 3 of the XP24 modules with the action „On 30 sec“ using channel 4 of the XP20. Program the relays 2 and 4 of all XPs with the action „On 30 sec“ using channel 5 of the XP20. Connect the inputs 4 and 5. Program in the window of the „Input Logic of XP20“ the following: check the checkboxes 4 and 5 on the line „short/long“. Invert input 5. The relays 2 and 4 control the blinds down, and the relays 1 and 3 control the blinds up. In case of a short impulse of the pushbutton, a start-command is sent to the Conbus and all blinds go up. In case of a long impulse of the pushbutton, all blinds go down.

### Short/long

The short/long-command responds differently depending on the action that has to be performed. Most actions that actors can perform are started by a short impulse. When the corresponding channel of the XP20 is inverted, it is a long impulse that performs the action. Only by using the action „Auxiliary relay“ (Help function), the short/long-function will do a start- and stop-command. This means that all actors (relay- and dimming modules) that are programmed with the action „Auxiliary relay“ (Help function) in relation to the input channel of the XP20 and to the short/long-function, will start with a short command and stop their actions with a long command. Some examples follow below.

##### Example 4

Situation: Hall-light, wall-light in the living room, dimmable lighting fixture in the seating area, kitchen-light. Desired mode: pushbutton in the entrance hall; with a short push, all these lights will turn on, and these lights will turn off with a long push. After a short push, the hall-light must stay on for 10 minutes. The light in seating area must be on and dimmed for 65%.

Solution:

Channel 5 of the XP20 short/long.

Action hall-light „Auxiliary relay“ and „On 10 minutes“

Action wall-light „Auxiliary relay“

Action dimmable lighting fixture „Auxiliary relay“ and light level 65%

Action kitchen-light „Auxiliary relay“

##### Example 5

Situation: The outdoor lights have 4 circuits. Each circuit can be controlled individually.

Desired mode: With one pushbutton, when pressed long, all outdoor-lights go on for 60 minutes and when pressed shortly the lights will turn off. This mode can also be used in stressful situations. When one is panicking, he/she has the intension to press the button for a long time. Whenever a potential-free contact of an alarm installation is switched simultaneously, the alarm will turn on the outdoor lights for one hour.

Solution:

Channel 6 of the XP20 short/long and invert.

Actions of the 4 actors of outdoor-lights „On 60 minutes“.

### Example 6

Situation: Child room has one dimmed light-point. Desired mode: short/short/long. With a short impulse, light turns on, and another short impulse it turns off. With a long impulse the light goes on for 5 minutes.

Solution:

Program in the XP20 channel 6 short/long and invert.

Connect channel 6 with channel 5.

Program the actor of the light-point of the child room as follows: „Impulse“ via channel 5 of the XP20

„On 5 minutes“ through channel 6 of the XP20

Previous mentioned solution can also work using a different way in case the pushbutton is connected with the direct input of the XP24. Make a connection between the direct input of the XP24 and input 6 of the XP20. Then one only needs the following programming: „On 5 minutes“ via channel 6 of the XP20.

### Groups on/off

Groups on/off is interesting when light-circuits need to be turned on and off using one pushbutton. The usual action assigned to a group of actors is „Auxiliary Relay“ (Help function). Without the function „Groups on/off“, the light-circuits will turn on when closing the pushbuttons and they will turn off when the pushbuttons are opened. The fact that the function „Groups on/off“ will be assigned to the alternate close/close of a pushbutton indicates that the lights will respectively go on and off. The action „Auxiliary relay“ can be followed by an action „Set light level to e.g. 75%“ and an action with timer for example „On for 10 minutes“.

### Example 7

On the floor of an office, there are 4 rows of dimmed light-circuits with outside glazing. It can be controlled with Dali using 4 pieces of XP31DD. At the beginning of the floor, there are 5 pushbuttons with LED-feedback (e.g.: pushbutton or CP2505 or other). The center button is connected to e.g. input 7 of an XP20. The others are connected to the direct inputs of the four XP31DD with their LED-feedback via the outputs of the modules.

Programming goes as follows:

„Auxiliary relay“ for all four XP31DD

Additional: Set light level to x-%

For light-circuit 1 the most close to the glass to 50%. For the light circuits 2, 3 and change it to 70%, 80% and 90%. The result is a similar light-distribution over the complete surface of the whole floor. When changing the light levels using the direct inputs of the XP31DD's, they will turn back to the original light level as mentioned above. By adding the action „Automatic light level“ the whole system will be better in energy saving. See the description of the XP31xx dimmers.

### AND-functions

An AND-function works when a specific input-channel of the XP20 sends a command on the bus when there is compliance with a specific condition. This condition can be that one or more channels must be active before the AND-channel can put data on the bus.

### Schematic

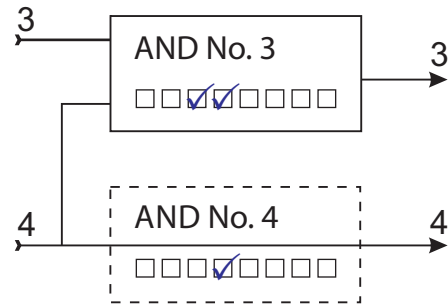

The schematic representations symbolizes two rows of checkboxes for the input- channels 3 and 4 of the XP20 as mentioned in the set-up window of the input logics of the XP20. It's the input-channel 3 that must be 'AND' with respect to input-channel 4. Thus, channel 4 must be active in order to place the command of channel 3 on the bus. When, for example, a dusk switch is connected to input 4, it can work freely. It is important to never use this type of sensor and to 'AND' it with another channel. Reason is that a twilight-switch can be used to turn on the stair-lights when it's getting dark by placing a movement sensor that turns on the lights outside for x-time.

### Example 8

Following situation: 3 pushbuttons in the hall, hall-light, outside lights and night-lights, sensor is a twilight-switch CP75S (channel 8). Potential free contact of the alarm center to channel 6.

Desired modes: pushbuttons „All on“ (channel 1) and „Welcome home“ (channels 3 and 4 connected in similar ways). With the „All off“-pushbutton, the command will only be active if the alarm is armed. Night lights „on/off“ by the setup of twilight-switch CP75S.

Programming of the actors goes as follows:

In the actor-window from the night-lights delete the action „Turn on“, as well as the checkmark in the checkbox of the „Member of all off“.

Action-actor night-lights „Auxiliary relay“ via trough channel 8.

Action-actors that want to do something in modes starting with „Turn on“ using channel 3 of the XP20.

Action-actors that have to be on with the mode „Welcome home“ when it's getting dark put „Turn on“ through channel 4.

Programming the AND-function:

AND No. 1          
 AND No. 4